



# AutoAnchor 150 V1.34

**LEWMAR®**

## Installation and Operation Instructions

# TABLE OF CONTENTS

<b>PART 1</b>	<b>IMPORTANT INFORMATION</b>
<b>PART 2</b>	<b>INSTALLATION</b>
<b>PART 3</b>	<b>SET UP</b>
<b>PART 4</b>	<b>USING THE AUTOANCHOR 150</b>
<b>PART 5</b>	<b>MAINTENANCE</b>
<b>PART 6</b>	<b>TROUBLESHOOTING</b>

## **PART 1 IMPORTANT INFORMATION READ BEFORE INSTALLING OR USING THE AA150**

- 1 The AA150 is a rope and chain or chain only rode counter. It does not control the windlass. A toggle switch, deck switch or handheld remote is required to operate the windlass.
- 2 The AA150 can be fitted to most vertical windlasses. A horizontal windlass may require a sensor holder or a custom designed sensor which is not included in the standard pack. Check with your supplier or the AutoAnchor manufacturer.
- 3 The AA150 should only be installed by a qualified marine electrician. Do not attempt to install the AA150 unless you are suitably qualified.
- 4 The AA150 must be fitted to a windlass with a dual direction control box or solenoid pack.
- 5 Information for installation and operation of the AA150 is supplied including preset windlass profile lists and wiring diagrams. All instructions should be left on board for the owner.
- 6 Non compliance with the instructions could impair the windlass and the AA150 operation, and could result in personal injury and/or damage to the boat.
- 7 Non compliance with the instructions will negate the manufacturer's warranty.
- 8 The AA150 manufacturer and supplier accept no liability for personal injury or property damage resulting from failure to follow the installation instructions or the use of the AA150 in a way that may cause accidents or damage or that may violate the law.
- 9 All the technical and cable specifications must be checked and adhered to.
10. Wiring diagrams must be followed without modification.
- 11 Installation is not complete until the AA150 has been set up to comply with the windlass and rode and then tested in a safe environment.
- 12 All installations must be carried out in accordance with USCG, ABYC, NMMA and BMEA requirements.
- 13 This manual supports the installation and use of the AA150 only. The appropriate manufacturer's instructions must be followed for the installation and use of the windlass it is connected to.
- 14 When this product reaches the end of its useful life it must be disposed of in accordance with local regulations.

## ELECTROMAGNETIC COMPATIBILITY (EMC)

### FCC Information:

This device complies with CFR47 Part 15 of FCC Rules for Class B equipment.

### ESTI Information (CE):

This device meets the relevant standards set out in European Standard EN 60945:2002 for maritime navigation and radio communication equipment and systems. These standards are intended to provide reasonable protection against interference by other emission generating products on the boat. Compliance with these standards is no guarantee that interference will not occur in a particular installation. The installation instructions must be followed to minimise the potential for interference.

**Note:** If shielded cable is not used for the sensor connections this will compromise the EMC and may invalidate the warranty.

The AA150 console must be installed at least 3 ft (1m) away from any transmission equipment or cables carrying radio signals eg VHF radios, cables and antennas or radar antennas; and at least 6 ft (2m) away from any SSB equipment. AA150 cables must be installed at least 1.5ft (500mm) away from such items.

## 1.1 TECHNICAL SPECIFICATIONS AA150

Power Supply	12V/24V DC
Current Consumption	30mA
IP Rating	IP65 from the front provided the unit is mounted so the back is protected from moisture.
Maximum Voltage	30V DC
Operating Temperature Range	23°F to 140°F (-5°C to 60°C)
Sensor	Compatible with all AutoAnchor sensors, reed switches and some proximity switches.
Rode - Chain Only	Stainless or galvanised steel.
Rode - Rope and Chain	Must have a minimum of 10ft (3m) of chain. Chain must be galvanised steel. Rope should be a good quality, nylon anchor rope. Type 66 or equivalent.
DC windlasses require a dual direction solenoid	

## 1.2 CABLE SPECIFICATIONS

**All Cables:** 1.0mm<sup>2</sup> (AWG18)

**Rope/Chain Connections:** If the brown and white wires are connected to the motor terminals for rope/chain counting short circuit protection is required. The load sensor terminators supplied have motor terminal connectors with a 1000 Ohm resistor prefitted. If these terminators are not used a 1000 Ohm resistor must be fitted near the motor terminal.



## 1.3 POWER SUPPLY

THE POWER SUPPLY MUST BE DISCONNECTED DURING INSTALLATION AND WHEN MAKING ANY CHANGES TO WIRING OR ELECTRICAL CONNECTIONS.

12V or 24V DC power supply is required to the AA150 console.

Check battery polarity before connecting power.

The power must be disconnected when installing and connecting the wiring.

A 5 Amp resettable isolating/breaker switch to shut off power to the AA150 and the windlass must be installed in a position easily accessed by the AA150 operator.

Multiple battery bank negative terminals must be permanently connected together to become the common negative return (ground).

Power to the AA150 and all windlass controls eg. toggle switch, remote switches, deck switches must be supplied from one point or the AutoAnchor will be damaged.

## PART 2 INSTALLATION

### 2.1 MAGNET AND SENSOR INSTALLATION

#### PLEASE READ BEFORE COMMENCING INSTALLATION

**Correct magnet and sensor installation is critical for successful AutoAnchor operation.**

The AutoAnchor can be installed on vertical windlasses and most horizontal windlasses. Installation differs depending on the windlass type and on the rode (all-chain or rope and chain). **Please follow the instructions for your windlass and rode.** If it is not possible to comply with these instructions please check with the AutoAnchor manufacturer or your supplier for other options or if you are not sure how to proceed.

See [www.autoanchor.co.nz](http://www.autoanchor.co.nz) for contact information.

#### 2.1.1 MAGNET INSTALLATION OVERVIEW

**Check before starting:** Your chainwheel may be prefitted with a magnet or predrilled ready for you to fit the magnet.

**Magnet Polarity:** Not relevant when using the grey AA sensor (#9067) or a reed switch sensor. If retrofitting, using the black AA sensor (#9008) the south pole (marked side) of the magnet must face the sensor.

**Magnet Seal:** Insert the magnet into the hole and cover it with a minimum of 1mm of epoxy to protect it against corrosion.

**Magnet Size and Position:** Refer to the instructions for your specific windlass type.

#### 2.1.2 SENSOR INSTALLATION OVERVIEW

**Vertical Windlasses:** The sensor is fitted in the deckplate. Some deckplates are predrilled for the sensor. Others have a dimple or mark to show where the sensor should be fitted. If the windlass is not factory drilled, drill a hole 10.3 mm (13/32") diameter through the windlass deckplate. See the instructions for your specific windlass type.

**Horizontal Windlasses:** Sometimes it is not possible to fit the sensor to a horizontal windlass or it may need to be fitted by the windlass manufacturer. Before starting check with the AutoAnchor manufacturer or supplier that it is possible to fit the sensor to your windlass. You may need a special fitting.

**Drilling the Deck:** Before drilling into the deck, ensure there is nothing below the deck that could be damaged and that any hole you drill will not weaken the boat's structure. Drill a hole 10.3mm (13/32") diameter through the deck. Ensure this hole is directly in line with the sensor hole in the deckplate.

**Fitting the Sensor:** Do not force the sensor into the hole. Hammering the sensor head can damage the internal electronics. Ensure the sensor head is positioned so that it will not be hit by the chainwheel during windlass operation and that it is at least 300mm (1ft) away from the battery and motor cables. Secure the sensor using a good quality neutral cure silicone or a strong adhesive eg. Sikaflex 291 or 3M 5200.

#### 2.1.3 PLUG AND PLAY SENSOR CABLE

The AutoAnchor plug and play sensor extension cable must be used to connect the sensor to the console unit.

Ensure the connectors are firmly screwed together.

**The warranty does not apply if the sensor cable plugs are removed.**

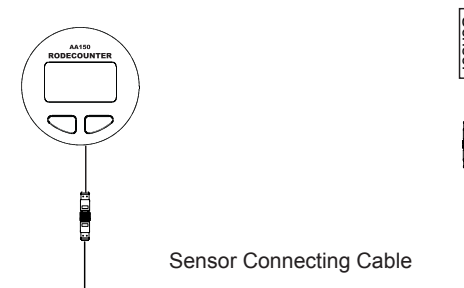

The sensor cable and the console sensor cable are fitted with female plugs. Sensor connecting cable with a male plug at each end is available in the following lengths:

6.5 m	(21.33 ft)	Part #9500
10 m	(32.81 ft)	Part #9501
15 m	(49.21 ft)	Part #9502
20 m	(66.62 ft)	Part #9503
25 m	(82 ft)	Part #9504
35 m	(114.83 ft)	Part #9514

#### Connecting 2 cables together:



If you need to extend the cable length - 2 cables can be joined together using Part #9510 Gender changer.

#### Field Connectors



Part #9507 Male Field Connector  
Part #9508 Female Field Connector

If there is no plug on the sensor or console cable attach the AA field connector to the wires and use the connecting cable as above.

## Dual Installation

Use the T junction connector Part #9506 and the 2m (Male/Female) extension cable Part #9505.



Part 9506

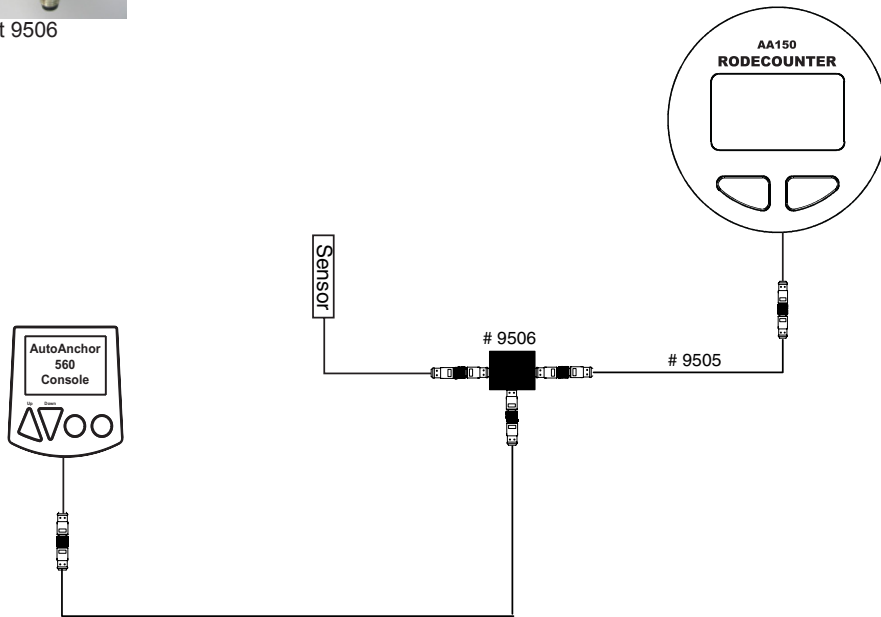

## 2.1.4 REED SWITCH SENSORS

Some windlasses are supplied pre-fitted with a reed switch sensor. Reed switch sensors must have a 10mm x 8mm magnet (#9061) and the gap between the reed switch sensor and the magnet must be a minimum of 3mm and a maximum of 5mm. This sensor will require a field connector.

The AutoAnchor will operate with a reed switch sensor for all-chain rode. If using rope/chain rode the reed switch sensor provides a reasonably accurate count of rode deployed but on retrieval the display may be incorrect because it cannot allow for the stretch in the rope.

For an accurate rope and chain count, the reed switch sensor should be replaced with the AA grey sensor (#9067).

## 2.1.5 INSTALLATION VERTICAL WINDLASS - CHAIN ONLY

Refer to the Overview Notes on page 4 before starting installation.

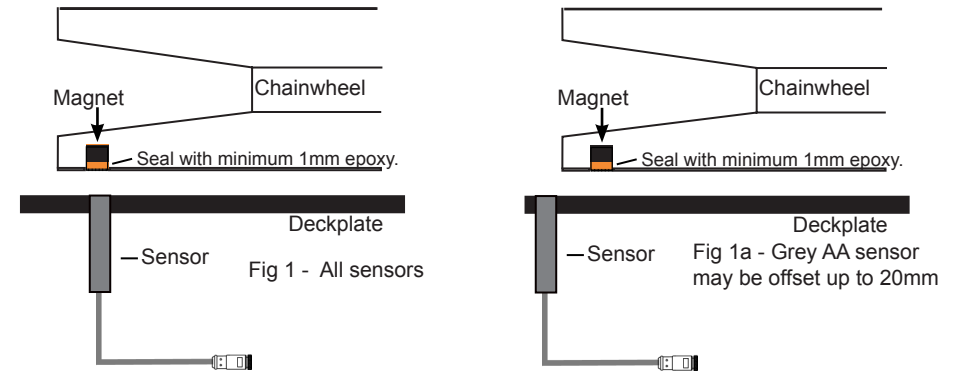

**Magnet Size:** Standard size is 10mm x 8mm (#9061). This may be replaced with the smaller 6mm x 4mm (#9009) magnet if required for your windlass.

**Magnet Fit:** Drill a hole 10.3mm (13/32") diameter and 9.5mm (3/8") deep to fit the magnet in the underside of a spoke in the bottom of the chainwheel. Cover the magnet with a minimum of 1 mm epoxy. The magnet must be aligned with the sensor. See Fig 1 & 1a.

**Sensor Position:** The AA black sensor and the reed switch sensor must be fitted directly in line with the magnet in the chainwheel. See Fig 1 above. The AA grey sensor may be fitted up to 20mm out of alignment. See Fig 1a above. The gap between the sensor and magnet must be as per the table below.

### Gap Between the Sensor and Magnet:

Sensor	Magnet Size	Gap
AA Grey Sensor #9067	6mm x 4mm	Minimum 3mm - Maximum 30mm
AA Grey Sensor #9067	10mm x 8mm	Minimum 3mm - Maximum 50mm
AA Black Sensor #9008	All Magnets	Minimum 3mm - Maximum 8mm
Reed Switch Sensor	10mm x 8 mm	Minimum 3mm - Maximum 5mm

**Sensor Connection:** The AutoAnchor plug and play sensor extension cable must be used to connect the sensor to the console unit. Ensure the connectors are firmly screwed together. See the information on page 5.

**Loose cable should be tied in place with cable ties and kept clear of chain.**

## 2.1.6 INSTALLATION VERTICAL WINDLASS - ROPE & CHAIN

Refer to the Overview Notes on page 4 before starting installation.

For an accurate rope and chain count, the rode must run between the sensor and magnet. If your windlass is prefitted with a magnet in the bottom of the chainwheel you need to remove it and fit a new magnet in the top of the chainwheel. Refer to Figs 2-4.

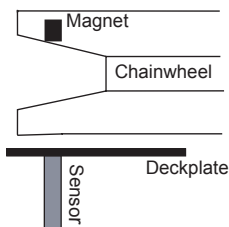
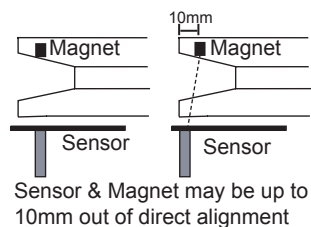

Fig 2



Sensor & Magnet may be up to 10mm out of direct alignment

Fig 3

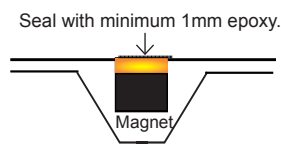

Fig 4

**Magnet Size:** 10mm X 8mm magnet (#9061). An 8mm x 6mm magnet (#9052) may be used on smaller windlasses. Check with your supplier.

**Magnet Fit:** Drill a hole 10.3mm (13/32") diameter and 9.5mm (3/8") deep into a spoke in the top of the chainwheel. Cover the magnet with a minimum of 1mm epoxy. The magnet and sensor must be aligned so that the anchor rode passes between them (See Figs 2 & 3).

**Sensor Position:** The sensor must be fitted into the deckplate within the sensor position range at the stern end of the windlass (See Fig 5). It must also be aligned with the magnet so that the rode passes between the sensor and the magnet. The centre of the magnet and the centre of the sensor may be up to 10mm out of direct alignment (See Fig 3). The gap between the sensor and magnet must be as per the table below.

### Gap Between the Sensor and Magnet

Sensor	Magnet Size	Gap
AA Grey Sensor #9067	8mm x 6mm	Minimum 30mm - Maximum 44mm
AA Grey Sensor #9067	10mm x 8mm	Minimum 35mm - Maximum 50mm

### Sensor Position Rope & Chain Vertical Windlasses

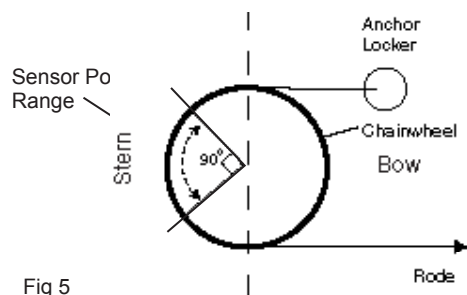

Fig 5

**Sensor Connection:** The AutoAnchor plug and play sensor extension cable must be used to connect the sensor to the console unit. Ensure the connectors are firmly screwed together. See the information on page 5.  
**Loose cable should be tied in place with cable ties and kept clear of chain.**

## 2.1.7 INSTALLATION HORIZONTAL WINDLASS - CHAIN ONLY

Refer to the Overview Notes on page 4 before starting installation. It is not possible to set out a single installation method for horizontal windlasses. The sensor may be fitted inside the windlass or you may need a sensor holder (Part #9070). Often the sensor and magnet can only be fitted by the windlass manufacturer.

### Magnet & Sensor Fitting for Chain Only Horizontal Windlasses

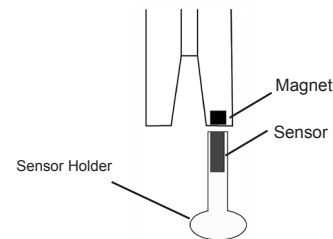

Fig 6

Magnet in rim of chainwheel and standard sensor in sensor holder screwed to the deck

**Magnet Size:** 6mm x 4mm magnet (#9009).

**Magnet Fit:** If your windlass is not predrilled drill a hole 6.5mm (1/4") diameter and 5mm (3/16") deep in the edge of the chainwheel. Cover the magnet with a minimum of 1mm epoxy.

**Sensor Position:** The AutoAnchor sensor may be fitted using a sensor holder fixed to the deck to sit under the chainwheel (See Fig 6). The AutoAnchor sensor holder (#9070) is not included in the standard kit. Check with your supplier if you need this. The AA black sensor and the reed switch sensor must be fitted directly in line with the magnet in the chainwheel. The AA grey sensor may be fitted up to 20mm out of alignment. The gap between the sensor and magnet must be as per the table below.

### Gap Between the Sensor and Magnet:

Sensor	Magnet Size	Gap
Grey AA Sensor #9067	6mm x 4mm	Minimum 3mm - Maximum 30mm
AA Grey Sensor 9067	10mm x 8mm	Minimum 3mm - Maximum 50mm
AA Black Sensor #9008	All Magnets	Minimum 3mm - Maximum 8mm
Reed Switch Sensor	10mm x 8mm	Minimum 3mm - Maximum 5mm

**Sensor Connection:** The AutoAnchor plug and play sensor extension cable must be used to connect the sensor to the console unit. Ensure the connectors are firmly screwed together. See the information on page 5.

**Loose cable should be tied in place with cable ties and kept clear of chain.**



## 2.1.8 INSTALLATION HORIZONTAL WINDLASS - ROPE & CHAIN

**Before starting check with the AutoAnchor manufacturer or supplier, that it is possible to fit the sensor and magnet to your horizontal windlass.**

For an accurate rope count the rode must run between the sensor and magnet. On a horizontal windlass the magnet and sensor must be fitted by the OEM windlass manufacturer.

If it is not possible to have the sensor and magnet fitted to achieve this you can use the chain only horizontal windlass installation above. **This provides an accurate count of rode deployed but during retrieval the display may be incorrect because it cannot allow for the stretch in the rope.**

## 2.2 CONSOLE UNIT INSTALLATION

1. Choose a position where the operator will be able to see the anchor and windlass when using the AA150.

2. The console should be mounted on a flat surface at least 3ft (1m) away from any equipment transmitting or cables carrying radio signals eg VHF radios, cables and antennas or radar antenna and at least 6ft (2m) away from any SSB equipment.

3. The console should be mounted where it is protected from the elements. The AA150 is splash proof and should not be placed in a position where it is likely to be immersed in water.

4. The panel for mounting the instrument should be 3mm to 19mm (1/8 to 3/4 inch) thick. The space behind the instrument panel must have a depth of at least 95mm (3.7inches).

5. Drill a 50mm (2-inch) hole in the instrument panel in the selected location.

6. With the mounting bracket removed, insert the instrument into the hole until the back of the face plate is flush with the outside mounting wall.

7. Slide the bracket over the body of the instrument. Note: Orient the bracket in such a manner that it does not cover the buzzer.

8. Tighten the mounting nut until the bracket is secure.

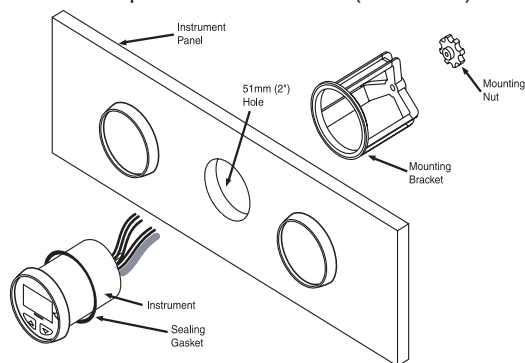

Fig 7 Console Installation

### 2.2.1 Multiple Console Unit Installation

Two AA150 consoles can be installed to provide multiple stations or the AA150 can be installed with other AutoAnchor products. All wiring for multiple AutoAnchor stations is colour matched and run in parallel.

A T-adaptor and 2m extension cable are available for dual installations. Refer to the wiring diagram and/or your supplier for details.

See the note below re wiring for multiple console installations.

For dual console operation, the sensor must be reset before calibrating the consoles. To do this clear the counter to zero twice. Press and hold any button. The AA150 will beep and clear within 4 seconds. rE will be displayed during the second clearing indicating the reset is okay.

## 2.3 WIRING

**All cables must be connected.** Refer to the Wiring Diagrams.

Interlock protection is included in the system. Do not fit diodes or interlock devices as these will prevent the system from operating correctly.

All battery and motor cables must be ring type, insulated to prevent short circuits and installed no closer than 1ft (300mm) away from the sensor head.

All main power conductors and terminations are to be installed according to the windlass manufacturer's specifications. Seal terminals against moisture by spraying with CRC [3013] Soft Seal or CRC [2043] Plasticoat 70. **Insulation must be used to protect all terminals.**

To reduce the potential for interference all cables must be located at least 1.5ft (500mm) away from any equipment transmitting or cables carrying radio signals eg VHF or SSB radios, cables and antennas or radar antennas.

Do not leave cables hanging loose, they must be tied in place with cable ties.

**Multiple Console Wiring:** It is important when wiring multiple console installations that potential differences do not occur along the ground connection. This can cause incorrect counting. Ensure consoles are star grounded and that there are no other high current paths between consoles. **All wiring for multiple installations is run in parallel.** Refer to wiring diagrams for further details.

### 2.5.3 CONNECTION TO LOW CURRENT WINDLASS DRIVES

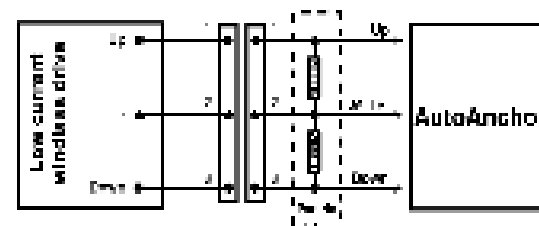

When connecting to solid state switching or other low current windlass drives eg PLC or AC variable frequency drives a dummy resistor load (Part # 9515) may be required to provide sufficient loading and to meet EMC and safety considerations. The resistor pack should be installed close to the windlass control **not on the AA150.**



## PART 3 SET UP



### 3.1 TO ENTER SET UP MODE:

The AA150 is automatically turned on when powered up.

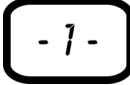
 +  To enter Set Up Mode: Press and hold both buttons together.

 The AutoAnchor version number (eg 1.31) is displayed briefly and then - 1 - appears. This takes about 8 seconds.

### 3.2 SELECT FEET OR METRES MEASUREMENT - Default Setting is u1 (Metres)

 The AA150 will flash between -1- and the current setting. Use the  or  buttons to select Feet or Metres.

U1 = Metres

U2 = Feet

 The selection is automatically saved 8 seconds after the last button press and the display changes to -2-

### 3.3 SELECT THE WINDLASS - Default setting is CH (Custom Chain Only Setting)

There are 3 windlass setting options:

1. A custom chain only windlass setting.
2. A custom rope and chain windlass setting for windlasses not on the pre-set windlass profile list.
3. Pre-programmed rope and chain windlass settings for windlasses on the pre-set windlass profile list.

Follow the instructions below to select the option for your windlass.

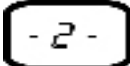
 The AA150 will flash between -2- and the current setting.



#### 3.3.1 CUSTOM CHAIN ONLY WINDLASSES - Default Setting CH

You need to know the length of chain per turn to enter these settings. See Appendix 1 or the instructions overleaf to calculate this.

If CH is not displayed, use the  button to select CH at -2-.

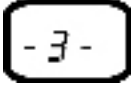
The display will automatically change to -3- approximately 8 seconds after the last button press.

 **Chain per Turn** - Default setting is **11.8 inches (300mm)**. The AA150 will flash between -3- and the current setting.

Use the  or  buttons to enter the chain per turn. If you selected Feet at Item 1 the setting is entered in inches (in increments of 0.10). See the table overleaf. If you selected Metres it is entered in millimetres. The entry is automatically saved 8 seconds after the last button press. **PrG** is briefly displayed.





#### 3.3.2 CUSTOM ROPE AND CHAIN WINDLASSES

You need to know the length of chain per turn and the length of rope per turn to enter these settings.

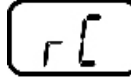
See the instructions overleaf to calculate this.



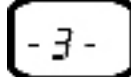

If CH is displayed, use the  button to select rC at -2-. If a number is displayed, use the  button to select rC at -2-.



**Chain per Turn** - Default setting is **11.8 inches (300mm)**.

The display will automatically change to -3- (Chain per Turn). The AA150 will flash between -3- and the current setting.



Use the  or  buttons to enter the chain per turn. If you selected Feet (u2) at Item 1 the setting is entered in inches (in increments of 0.10). See the table overleaf.

If you selected Metres (u1) it is entered in millimetres.



The display changes to -4- (Rope per Turn) approximately 8 seconds after the last button press.

**Rope per Turn** - Default setting is **10.8 inches (275mm)**.



The AA150 will flash between -4- and the current setting.





Use the  or  buttons to enter the rope per turn in feet or metres as you did for chain.

The entry is automatically saved 8 seconds after the last button press. **PrG** is briefly displayed.

#### 3.3.3 PRE-PROGRAMMED ROPE AND CHAIN WINDLASSES

See Appendix 1 for the list of windlass profiles.



If CH is displayed, use the  button to select rC at -2-. If a number is displayed, use the  button to select rC at -2-.

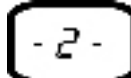

When rC is displayed. Press the  button to access the windlass profiles.

The display will flash between -2- and the current setting. Use the  button to enter the windlass profile from the list in Appendix 1.

Use the  button to go back if necessary.

If you use this option there are no further settings. Your selection is automatically saved 8 seconds after the last button press.

**PrG** is briefly displayed and the unit returns to the idle state.



### Calculating the chain per turn

This is the length of chain that is released during one complete revolution of the chainwheel. The chain per turn for some windlasses is listed in Appendix 1. If your windlass is not listed follow the instructions below to calculate it.

- Step 1 Use adhesive tape to place a mark on the chainwheel.
- Step 2 Use adhesive tape to place a mark on the chain coming out of the chain wheel.
- Step 3 Use adhesive tape to place a mark on the deck below the mark on the chain.
- Step 4 Carefully release the chainwheel so that it can be turned by hand to feed the chain out.
- Step 5 Using the mark on the chainwheel as a guide, turn the chainwheel one revolution, causing the chain to be released on to the deck.
- Step 6 Measure the length of chain from the mark on the deck to the mark on the chain.
- Step 7 Enter this measurement.

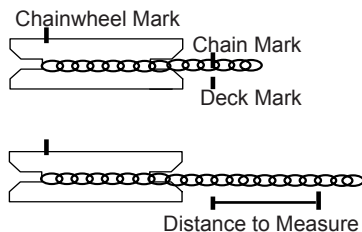

### Calculating the rope per turn

This is the length of rope that is released during one complete revolution of the chainwheel. You need to measure the length of rope pulled through for 10 revolutions and divide the result by 10. See instructions to calculate the rope per revolution below.

- Step 1 Carefully release the chainwheel so that it can be turned by hand to feed the rode out until you have rope.
- Step 2 As you did for the chain, use adhesive tape to mark the chainwheel, the deck and the rope. (See the instructions for the chain per revolution above).
- Step 3 Using the mark on the chainwheel as a guide, pull the rope out by hand until the chainwheel has completed 10 revolutions.
- Step 4 Measure the length of rope pulled, divide it by 10.
- Step 5 Enter this measurement.

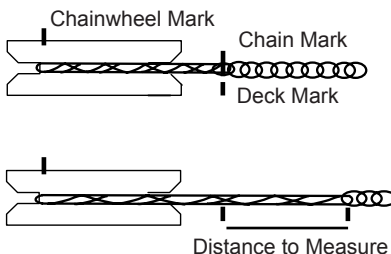

### Metric Inches Conversion Table

Inches	Metric Inches	AutoAnchor Setting (to 1 decimal point)
1/8	0.125	0.1
1/4	0.25	0.3
3/8	0.375	0.4
1/2	0.5	0.5
5/8	0.625	0.6
3/4	0.75	0.8
7/8	0.875	0.9

## PART 4 USING THE AA150

### 4.1 INSTALLATION, SET UP AND TESTING

**Before the AA150 is used it must be set up for the windlass and rode on the boat and tested in a calm, safe environment. Use the windlass to raise and lower the anchor. If the AA150 does not count, or any diagnostic messages appear on the screen, refer to Troubleshooting (Part 5), your supplier or the AutoAnchor manufacturer for assistance.**

### 4.2 OPERATION

The AA150 is automatically turned on when the windlass is powered up. When the windlass is operated the AA150 displays the length of anchor rode deployed. The unit will remember the settings entered and the count even when the power is turned off. It will also beep during retrieval to warn the skipper the anchor is within 1.5 metres (4 feet) of docking.

If counting greater than 99.9 metres or feet the display will drop off the decimal place and display only whole metres or feet.

Note: If there is a sensor or a load error the AA150 will not count accurately. (Refer to Troubleshooting Part 5)



### Notes When Anchoring

The AA150 helps to make anchoring less stressful but nothing can replace good seamanship and safe boating practices.

#### When anchoring:

- use the windlass strictly according to the windlass manufacturer's instructions;
- personally control and supervise all windlass and anchoring operations;
- maintain a clear view of the windlass, rode and/or anchor during windlass operation; and
- always ensure the anchor is fully docked and secured before moving the boat.

#### 4.3 CHANGE BACKLIGHTING LEVEL (This is best done in low light).

Tap either button  $\oplus$  /  $\ominus$  to adjust the light level up and down. There are 4 light levels.

#### 4.4 RESET DISPLAY TO ZERO

Press and hold the  $\ominus$  key. The AA150 will beep and the display will clear to 0.0 within 4 seconds.

#### 4.5 RESET FACTORY DEFAULT SETTINGS

**This will remove your individual set up.**

Turn the power off.

Press and hold both keys together  $\oplus$  +  $\ominus$  while turning the power on again.

Release the keys when the display reads **FCt dEF**.

This will restore the factory default settings.

**Now re-enter the set up for your unit. Refer Part 3 of this document.**



## PART 5 MAINTENANCE

The AA150 does not contain any user serviceable parts. User maintenance is limited to :

- Checking all cables and connections for signs of wear or damage and replacing them as necessary.
- Checking the sensor head is not worn and has not moved out of alignment and replacing the sensor if necessary.
- Checking the magnet is not worn or corroded and replacing the magnet if necessary.

**Note:** Do not use chemical or abrasive materials to clean the console unit. If it is dirty wipe it with a clean damp cloth. Avoid wiping the display screen with a dry cloth as this could scratch the screen.

## PART 6 TROUBLESHOOTING

**The AutoAnchor is not faulty if these messages display.**

The diagnostics help identify problems with the installation and sensor.

The messages display briefly during operation and/or power up. A beep will sound and after 3 seconds the message will be cleared.

**The count will not be accurate until the cause of the error is fixed.**

**After the windlass is retrieved and the error is fixed reset the AA150 by holding down one of the buttons to zero the display.**

Use the table below to help identify a problem and provide a possible solution. If you cannot resolve the problem, contact your supplier for further information.

Problem	Possible Solution
<b>Sn 1</b> Appears during operation. The AA150 does not count and does not display a sensor pulse.	No signal from the sensor to the AA150. Either there is no magnet, the gap between the magnet and sensor is too big or the sensor signal is out of tune because of testing during installation. Try resetting the AA150 by running the windlass up and down for 10-15 seconds. If the message still appears check the magnet and the gap and alignment between the magnet and sensor. Check sensor wiring and installation and check for damage to the sensor and magnet. When fixed reset the AA150 as above. For manual reset, clear the counter to zero twice. To clear to zero press and hold any key. The AA150 will beep and clear within 4 seconds. rE will be displayed during the second clearing indicating the reset is okay.
<b>Sn 2 (Rope/Chain Only)</b> Appears during operation. The AA150 will count and will display a sensor pulse. The count will not be accurate.	Sensor is too close to the magnet. Ensure the gap between the magnet and sensor is no less than 35mm for a 10mm x 8mm magnet and 30mm for an 8mm x 6mm magnet. The count will not be accurate until the problem is fixed. Fix the installation and reset the counter to zero.
<b>Sn 3 (Rope/Chain Only)</b> Appears during retrieval when using a rope/chain rode. The AA150 will count and will display a sensor pulse. The count will not be accurate.	The AA150 has failed to detect the change from rope to chain or there has been excessive rope slippage. Complete retrieval and then reset the counter to zero. This message may also display if the chain is the wrong size for the chainwheel.
<b>Sn 4</b> Appears during AA150 power up. AA150 will not count but it will display a sensor pulse.	The orange wire to the Up solenoid is not connected. Fix the wire connection and reset the counter to zero.

### Ld (Rope/Chain Only)

Appears during AA150 power up. The AA150 will count up. The AA150 will count and will display a sensor pulse. The count will not be accurate.

The load sensor wires are not connected to the motor. Fix the connection and reset the counter to zero.

---

AA150 counts when the windlass is not turning or counts erratically displaying a large number eg 888.

The sensor could be damaged, incorrect cable may be fitted, or the AA150 may have been subject to external interference, either RF or electrical. Check that the sensor cable is not damaged and that the specified cable has been fitted. Check for external interference on the boat eg damaged or loose RF cables or aerials or other instruments that may not be working correctly or have been damaged by electrical interference including lightning.

---

The count pauses during retrieval.

This is not a fault. The rode is changing from rope to chain.

---

### FOR ADDITIONAL TROUBLESHOOTING:

Contact AutoAnchor support on:

[www.autoanchor.co.nz/autoanchor-installation-help.php](http://www.autoanchor.co.nz/autoanchor-installation-help.php) Fill in the information form.

Email: [support@autoanchor.co.nz](mailto:support@autoanchor.co.nz) or Telephone: +64 9 419 1219

To the best of our knowledge the information in these instructions was correct at the time of printing. However, the AutoAnchor products are continuously being reviewed and improved and product specifications may be changed without notice. The latest product specifications may not be reflected in this version of the instructions. The documentation relating to the AutoAnchor products is created in the English language and can be translated from English to another language. In the event of any conflict between translated documents, the English language version will be the official version.

---

## LEWMAR®

### UK and International Distribution

Lewmar  
Southmoor Lane  
Havant  
Hampshire PO9 1JJ  
England  
Tel: +44 23 9247 1841  
Fax: +44 23 9248 5720  
Email: [info@lewmar.com](mailto:info@lewmar.com)

### USA

Lewmar Incorporated  
351 New Whitfield Street  
Guilford CT 06437  
USA  
Tel: + 1 203 458 6200  
Fax: + 1 203 453 5669  
Email: [info@lewmar.com](mailto:info@lewmar.com)

### Australia/Asia

Lewmar Navtec Australasia Pty Ltd  
4/224 Headland Road  
Dee Why  
New South Wales 2099  
Australia  
Tel: +61 2 9936 7111  
Fax: +61 2 9936 7112  
Email: [info@lewmar.com.au](mailto:info@lewmar.com.au)